

**SANY**

品质改变世界

# SSR200AC-8H SINGLE DRUM ROLLER

## SSR200AC-8H 单钢轮压路机

### HIGH EFFICIENCY

- ◆ 10% greater excitation force than other products in the same category resulting in 16.7% greater production.

### OPERATOR COMFORT

- ◆ Cab mounted on vibration damping mounts
- ◆ Cab temperature control
- ◆ Operator control forces have been reduced

### SAFETY FEATURES

- ◆ Rounded bumpers front and rear
- ◆ Large rear glass and sloped hood for greater visibility

### EXTENDED LIFE TIME

- ◆ The use of water wheel type lubrication on the vibratory bearing extends the bearing life up to 5,000 hours.
- ◆ Double filtration of engine high intake air, the hydraulic system contains three stage filtration.

#### 更高的压实作业效率

- ◆ 激振力在行业中比同类型号高出 10%，压实作业效率提升 16.7%

#### 更长的整机使用寿命

- ◆ 独创鼠袋式润滑装置充分润滑轴承，轴承使用寿命达 5000h 以上
- ◆ 发动机高位进气双重滤清，油路三级过滤

#### 更安全的人性化设计

- ◆ 前后保险杠确保操作手的安全
- ◆ 大后窗玻璃和倾斜的引擎盖提供更大的能见度

#### 舒适的操作环境

- ◆ 驾驶室安装在减振支架上
- ◆ 驾驶室温度可控制
- ◆ 操作员控制力已减少

# TECHNICAL PARAMETERS

## 技术参数

### SSR200AC-8H 单钢轮压路机技术参数

SSR200AC-8H Single Drum Roller Technical Parameters

型号 Model		SSR200AC-8H
质量载荷参数 Weight and Load	工作质量 Operating Weight(kg)	20000
	振动轮分配质量 Weight at Drum(kg)	10000
	驱动桥分配质量 Weight at Rear axle(kg)	10000
	振动轮静线载荷 Drum Static Linear Load(N/cm)	470
压实机构参数 Compaction	振动频率 Vibration Frequency (Hz)	29/35
	名义振幅 Nominal Amplitude(mm)	1.9/0.95
	激振力 Excitation Force(kN)	368/258
	振动轮直径 Drum Diameter(mm)	1600
	振动轮宽度 Drum Width(mm)	2130
	振动轮轮圈厚度 Drum Edge Thickness(mm)	40
机动性能参数 Maneuver Ability	行驶速度 Travel Speed(km/h)	0~5 0~8
	理论爬坡能力 Gradeability	30%
	最小离地间隙 Ground Clearance(mm)	440
	轴距 Wheelbase(mm)	3185
	转向角度 Steering Angle(°)	±35
	摇摆角度 Swing Angle(°)	±12
	最小转弯外直径 Min. Turning Outside Diameter(mm)	12350
发动机 Engine	轮胎规格 Tires	20.5-25-16PR
	供应商 Brand	WEICHAI
	型号 Model	WP6G200E331
	排放 Emission	China III
容量参数 Capacity	额定功率 Rated Power(kW)	147
	蓄电池 Battery(V×Ah)	24×120
	燃油箱 Fuel Tank(L)	300
	液压油箱 Hydraulic Oil Tank(L)	100

### 单钢轮压路机 SSR200AC-8H 标配选配表

Single Drum Roller SSR200AC-8H Standard and Optional Configurations

配置类型 Config	配置名称 Systems	物料名称 Description	数量 / 台 Quantity	详细说明 Details	备注 Remarks
标准配置 Standard Configuration	主机 Main Machine	SSR200AC-8H 单钢轮压路机标配	1	1.Engine 发动机 2.Travel Pump 行驶泵 3.Vibration Pump 振动泵 4.Travel Motor 行驶马达 5.Vibration Motor 振动马达 6.Operating Platform 操作平台 7.Vibratory Drum (Smooth) 振动轮 (光轮) 8.Electrical System 电气系统	9.Operating System 操纵系统 10.Front Frame 前车架 11.Rear Frame 后车架 12.Covering Part 覆盖件 13.Rear Axle Assembly 后桥总成 14.Center Articulated Frame 中心铰接架 15.Cab+A/C 驾驶室 + 空调
		SSR200AC-8H Single Drum Roller, Standard			
可选配置 Optional Configuration	驾驶棚 Shed	驾驶棚 Shed	1	低成本 Low Cost	选配 Optional
	焊接式凸块振动轮 Vibratory Drum with Welded pad foot	凸块振动轮 Drum with Welded pad foot	1	振动轮焊接凸块, 用于粘土、半粘土、岩石、碎石、膨胀土、煤渣等地基的压实, 而且凸块不能拆卸 Vibratory drum with welded pad foot, which cannot be removed, suitable for compaction of clay, semi-clay, rocks, gravels, expansive soil, and coal cinder base	可选配替代光轮 Substitute smooth drums permissible
	装配式凸块振动轮 Vibratory Drum with Assembled pad foot	装配式凸块总成 Drum with Assembled pad foot	1	振动轮装配凸块总成, 用于粘土、半粘土、岩石、碎石、膨胀土、煤渣等地基的压实, 拆卸凸块后, 可以作光轮压实, 实现一机两用。 Vibratory drum with assembled pad foot, which can be removed to form a smooth drum; suitable for compaction of clay, semi-clay, rocks, gravels, expansive soil, and coal cinder base	选配 Optional

### 单钢轮压路机 SSR200AC-8H 尺寸参数

Dimensions of SSR200AC-8H Single Drum Roller

主要尺寸 Size Code	SSR200AC-8H
A(mm)	3185
W(mm)	2318
L(mm)	6620
D(mm)	1600
H(mm)	3330
B(mm)	2130
K(mm)	440

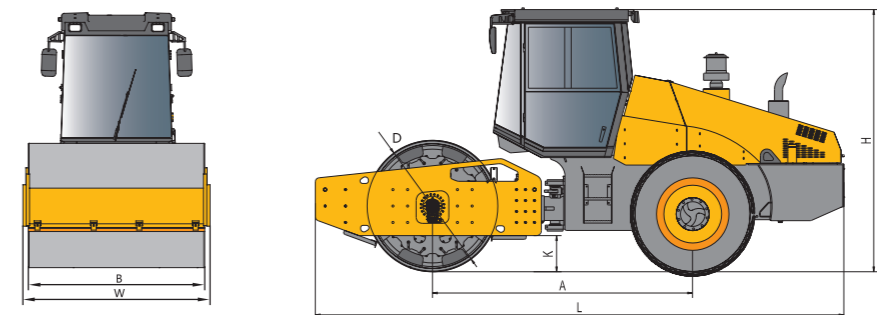

SANY HEAVY INDUSTRY CO., LTD.

SANY Industry Town, Changsha Economic and Technological Development Zone, Hunan Province, China

Service Line: +86 4006 098 318 E-mail: crd@sany.com.cn

**SANY**<sup>®</sup>  
QUALITY CHANGES THE WORLD.