



SCC450A-6

Crawler Crane

45 Tons Lifting Capacity

Quality Changes the World



Max lifting capacity: 45t
Max. boom length: 40m
Max. boom+jib: 31m+15.25m

The parameters, pictures and standard/optional equipment are only for reference in this brochure, the actual machine is based on the effective price list and contract.



Crawler Crane Series SCC450A-6

P03

Main
Characteristics

- Product Specification
- Safety Device

P09

Technical
Parameters

- Major Performance & Specifications
- Outline Dimension
- Transport Dimension
- Transport Plan

P16

Cofigurations

- H Configuration
- FJ Configuration



SCC450A-6
SANY CRAWLER CRANE
45 TONS LIFTING CAPACITY

QUALITY CHANGES THE WORLD

Main Characteristics

- Page 04 Product Specification
- Page 07 Safety Device



Product Specification



Engine

- Model: WP4.1NG175E300 Diesel Engine;
- Type: 4-stroke, water-cooled, vertical in-line, direct injection, turbo-charger, intercooler, complied with Chinese Non-road Tier III Emission Standard;
- Displacement: 4.1L;
- Rated power: 129kW/2300rpm;
- Operation power: 117kW/2000rpm;
- Max. Torque: 680N·m/1400-1600rpm;
- Starter: 24V-4.75kW.

Electrical Control System

- Self-developed SYIC-II integrated control system is adopted with higher integration, precise operation and reliable quality;
- Control system consists of power system, engine system, main control system, LMI system, auxiliary system and safety monitoring system. CAN BUS is used for data communication between controller, monitor and the engine;
- Monitor: the working parameters and status are shown on the monitor, such as the engine speed, fuel volume, engine oil pressure, servo pressure, engine working hours, lifting conditions and boom angle.

Hydraulic System

- Main pumps: open variable displacement piston pumps are adopted to provide oil supply for main actuators of main machine;
- Gear pump: dual-gear pump for swing and control circuit;
- Control: main pump adopts positive flow proportional control; main load winch motor adopt piston motor of variable displacement; aux. load winch and boom hoist winch motor adopts piston motor of fix displacement. The operating components adopt two cross hydraulic handles, one dual travel pedal control valve, to control various actuators proportionally;
- Way of cooling: heat exchanger, fan core and multi-stage cooling;
- Filter: large flow, high precision filter, with bypass valve and transmitter, which can remind the user to replace the filter element in time;
- Max. pressure of system: 34MPa;
- Main/aux. load hoist, boom hoist and travel system: 32MPa;
- Swing system: 24MPa;
- Control system: 5MPa;
- Hydraulic Tank Capacity:305L.

Main and Aux. Load Hoist Mechanism

- Main and aux. hoist winches are driven separately by motor via gearbox. Operating winch handle can control the winch to rotate to two directions, which are lifting and lowering of hook. Excellent inching function is equipped on the machine;
- Drums with fold-line grooves can ensure the wire rope reeved in order in multilayers;
- Free fall hook for standard offering main load hoist but not for aux. load hoist.

Main Load Hoist Mechanism	Drum diameter	449mm
	Rope speed	0~75m/min
	Wire rope diameter	Φ16mm
	Wire rope length of main load hoist	180m
	Rated single line pull	5t
Auxiliary Load Hoist Mechanism	Drum diameter	406mm
	Rope speed	0~125m/min
	Wire rope diameter	Φ16mm
	Wire rope length of auxiliary load hoist	120m
	Rated single line pull	5t



Product Specification

Boom Hoist Mechanism

- Boom hoist winches are driven separately by motor via gearbox. Operating winch handle can control the winch to rotate to two directions, which are lifting and lowering of boom;
- Drums with fold-line grooves can ensure the wire rope reeved in order in multilayers.

Boom hoist mechanism	Drum diameter	355mm
	Rope speed	0~60m/min
	Wire rope diameter	Φ16mm
	Wire rope length of boom hoist	100m

Swing Mechanism

- Swing brake adopts wet, spring loaded, normally-closed brake, and braking through spring force;
- With integrated cushion valve, the swing system has free slip function to realize steady swing start and control, showing outstanding microinching performance; Unique swing cushion design ensures more stable braking;
- Swing drive: external engaged swing drive with 360° swing range, and the max. swing speed is 2.5rpm;
- Swing lock: cylinder lock can ensure the upperworks locked securely on four directions after work or during transport;
- Swing ring: single row ball bearing.

Cab and Control

- Novel operator's cab with fashionable profile, nice interior and large glass window. There are low and high-beam lights, back-view mirror, heater and A/C, radio and other functions. The layout of seat, handles, control buttons are designed with ergonomic principles to make operation more comfortable;
- Cab layout: Integrated 7-inch touch screen, man-machine interaction interface are more perfect;
- Armrest box: on the left and right armrest box are control handles, electrical switches, emergent stop and ignition switch. The armrest box can be adjusted along with the seat;
- Seat: multi-way and multi-level floating adjustable seat with unload switch;
- A/C: cool and heat air; optimized air channels and vents;
- Multiple cameras can present at the same time to realize real-time monitoring of machine traveling, right crawler, conditions behind the counterweight and surrounding the machine.

Counterweight

- Counterweight tray and blocks are in stack for easier assembly and transport;
- Total rear counterweight: approximately 10.5t;
- Rear counterweight: counterweight tray 6t×1, counterweight block 4.5t×1.

Upperworks

- High-strength steel weld framework, with no torsion or deformation. The parts are laid out in the way that is easier for maintenance and service.

Product Specification



Travel System

- Independent travel driving units are adopted for each side of the crawler, to realize straight walking and turning driven by travel motor through gearbox and drive wheel;
- Travel Speed: both high and low speed are set, and the highest speed is 2.2km/h;
- Gradeability: 40%.

Travel Brake

- Concealed wet type and spring-loaded type normally engaged brake, spring force braking, oil pressure released.

Crawler Extension and Retraction

- The crawlers can extend and retract via cylinders. During Work Mode, the crawlers must be extended, and be retracted during transport with crawlers on.

Crawler Tensioning

- Spring tensioner with auxiliary hydraulic cylinder regulates the tension degree through charging grease, and the spring can perform buffer and protection function when traveling.

Steering System

- It can realize single track turning and pivot turning.

Track Shoe

- Excavator three-reinforcement chain link track shoe is adopted, which is made of high strength alloy cast steel, has stronger road holding capacity and longer service life, and can adapt to various harsh road conditions.. Width 700mm, Qty 60x2.

Track Roller

- Maintenance-free track roller.

Operating Equipment

- All chords are high-strength steel tubes, and the boom/jib top sheaves are made of high-strength anti-wearing Nylon material protecting wire rope. The hooks are installed with milled welded steel sheave.

Boom

- Lattice structure. The chord adopts high-strength structural tube and each section is connected through pins;
- Basic boom: 5.5m boom base + 4.5m boom top ;
- Boom insert: 3m×1, 6m×1,9m×2;
- Boom length: 10m~40m.

Jixed Jib

- Basic boom:3.05m boom top+3.05m boom base;
- Boom insert:3.05m×3;
- Fixed boom length:6.1m~15.25m;
- Max. boom+jib:31m boom +15.25m jib.

Extension Jib

- The extension jib is a welded structure connected to the boom top by pins, used for auxiliary hook;
- Extension jib length: 0.8m.

Hook

- 45t hook, 5 sheaves;
- 5t ball hook.



Safety Device

Assembly Mode/Work Mode Switch

- In Assembly Mode, certain safety devices are disabled to facilitate crane assembly;
- In Work Mode, all safety devices activate to protect the operation.

Emergent Stop

- In emergent situation, this button is pressed down to cut off the power supply of the whole machine and all actions stop.

Load Moment Indicator (LMI)

- It is an independent computerized safety control system. LMI can automatically detect the load weight, work radius and boom angle, and present on the display the rated load, actual load, work radius and boom angle. In normal operation, the LMI can make a judgment and cut off automatically if the crane moves towards dangerous direction. It can also perform as a black box to record the lifting information;
- It is composed of monitor, angle sensor, force sensor and other parts.

Over-hoist Protection of the Main/ Auxiliary Load Hoist

- Over-hoist protection device comprises limit switch and weight on boom top, which prevents the hook lifting up too much. When the hook lifts up to the limit height, the limit switch activates, buzzer on the right control panel sends alarm, failure indicator light starts to flash and the hook hoisting action is cut off automatically.

Over-release Protection Device of the Main/Auxiliary Load Hoist

- It is comprised of activator in the drum and proximity switch to prevent over release of wire rope. When the rope is paid out close to the last three wraps, the proximity switch acts, and the system sends alarm through buzzer and show the alarm on the monitor, automatically cutting off the winch action.

Function Lock

- If the function lock level is not in work position, all the other handles won't work, which prevents any mis-operation caused by accidental collision.

Boom Hoist Drum Lock

- Boom luffing lock switch is designed to lock the boom luffing winch when it doesn't work, so as to prevent mis-operation. Boom hoist winch pawl can automatically respond when the control handle moves; and the pawl locks the drum when the handle returns to neutral position, so that the boom can stay safely when not working.

Swing Lock

- Swing Lock can lock the lowerworks and upperworks together.

Boom Limit Device

- When the boom elevation angle reaches the upper limit, the buzzer sounds and boom action is cut off. This protection is two-stage control ensured by both LMI system and travel switch.

Back-stop Device

- Its major components are nesting tubes and spring, in order to buffer the boom backlash and prevent further tipping back.

Hook Latch

- The lifting hook is installed with a baffle plate to prevent wire rope from falling off.

Safety Device



Tri-color Load Indicator

- The load indication light has three colors, green, yellow and red, and the real time load status is presented on the display. When the actual load is smaller than 90% of rated load, the green light is on; when the actual load is larger than 90% and smaller than 100%, the yellow light is on, the alarm light flashes and sends out intermittent sirens; when the actual load reaches 100% of rated load, the red light is on, the alarm light flashes and sends out continuous sirens. When the actual load reaches 100% of the rated load, the system will automatically cut off the crane's dangerous operation.

Alarm Light

- When the machine is powered on, the alarm light will work when time comes, so as to warn people around.

Swing Indicator Light

- The swing indicator light flashes during traveling or swing.

Illuminating Light

- The machine is equipped with short-beam light in front of machine, front angle adjustable far-beam light, lamps in operator's cab, lighting devices for night operation, so as to increase the visibility during work.

Rearview Mirror

- It is installed on the left of the operator's cab and at the front handrail of the sheet metal for monitoring the rear part of the machine.

Pharos

- Pharos is mounted on the top of boom/jib to indicate the height.

Anemometer

- It is mounted on the top of boom/jib, indicating the height.

Electronic Level Gauge

- It displays the tipping angle of crane on the monitor in real time and sends out alarm to the operator automatically when the angle is out of limit.

Engine Power Limit Load Adjustment and Stalling Protection

- The controller monitors the engine power to prevent engine getting stuck and stalling.

Engine Status Monitoring

- The engine status will be presented, such as engine coolant temperature, fuel volume, total work hours, engine oil pressure, engine speed, battery charging and voltage.

Monitoring System

- Remote Monitoring system(using local 4G network) is a standardized offering to provide functions like GPS locating, GPRS data transfer, machine status inquiry and statistics, operating data monitoring and analysis, remote diagnosis of failures.



SCC450A-6
SANY CRAWLER CRANE
45 TONS LIFTING CAPACITY

QUALITY CHANGES THE WORLD

Technical Parameters

- Page 10 Major Performance & Specifications
- Page 11 Outline Dimension
- Page 12 Transport Dimension
- Page 15 Transport Plan

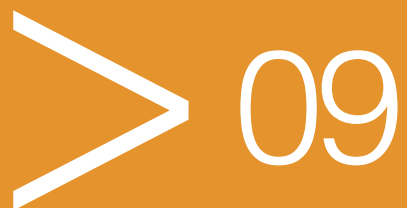

Major Performance & Specifications

Major Performance & Specifications of SCC450A-6		Unit	Parameter
Performance Indicators			
Boom configuration	Max. rated lifting capacity	t	45
	Max. lifting moment	t·m	150
	Boom length	m	10~40
Fixed jib configuration	Max. rated lifting capacity	t	5
	Jib length	m	6.1~15.25
	Max. boom+jib	m	31+15.25
Speed	Rope speed of main winch	m/min	0~75
	Rope speed of aux. winch	m/min	0~125
	Rope speed of boom hoist winch	m/min	0~60
	Swing speed	rpm	0~2.5
	Travel speed	km/h	0~2.2
Wire rope	Main load hoist wire rope: diameter × length	φ mm × m	16×180
	Aux. load hoist wire rope: diameter × length	φ mm × m	16×120
	Rated single line pull of main/aux. load hoist wire rope	t	5
Engine	Model	-	WP4.1NG175E300
	Rated power/revolution speed	kW/ rpm	129/2300
Transport parameters	Weight of machine with basic boom	t	35
	Rear counterweight	t	10.5
	Transport weight of basic machine (with crawlers and boom base)	t	23.5
	Machine transport dimension (with crawlers and boom base) L×W×H	mm	11035×3000×3250
Other specifications	Average ground pressure (basic boom)	MPa	0.05
	Gradeability	%	40

Unit: mm

Outline Dimension

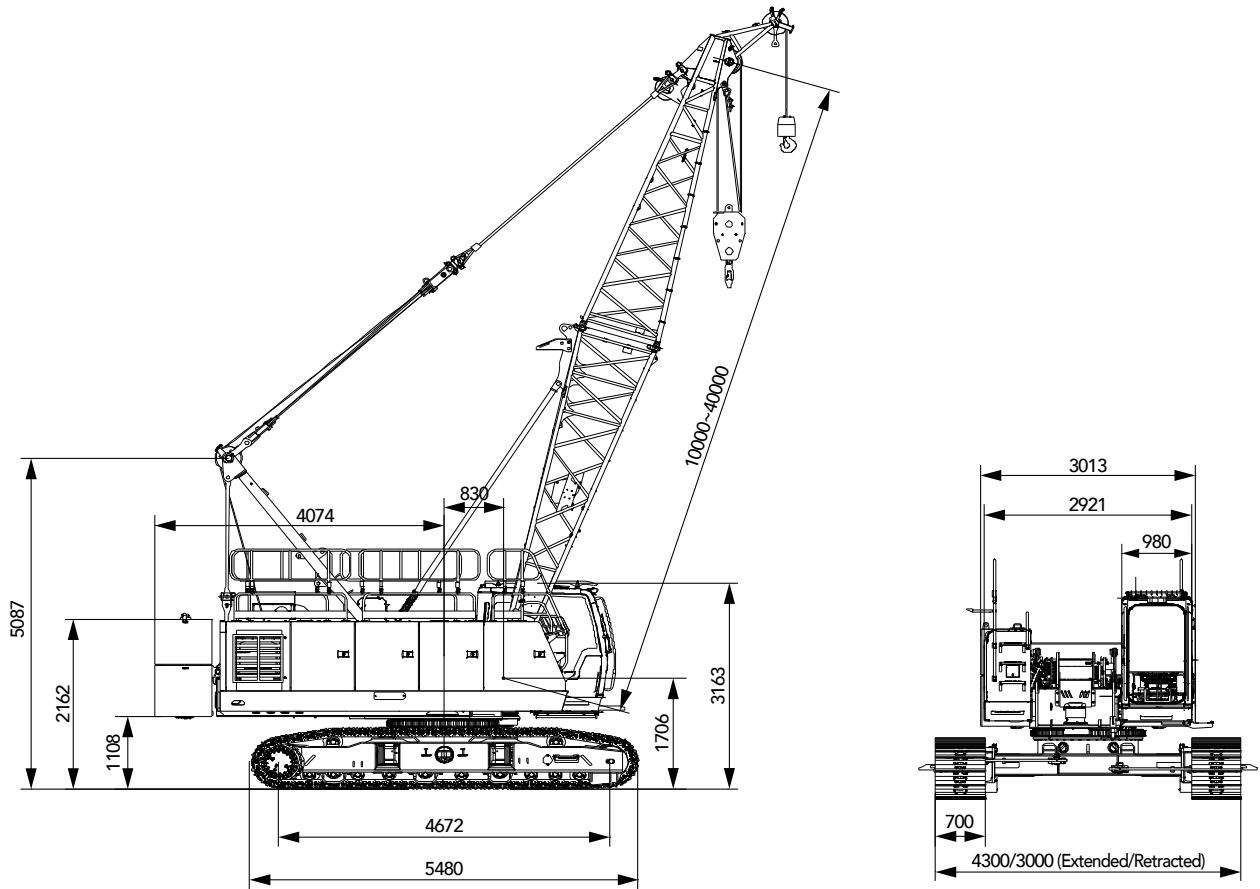

Transport Dimension

Note:

- 1.The transport dimensions of each part in the table are schematic, not proportional to the real parts. The dimensions are designed value without package considered.
- 2.The Weight is designed value that the actual manufactured part may deviate a little.

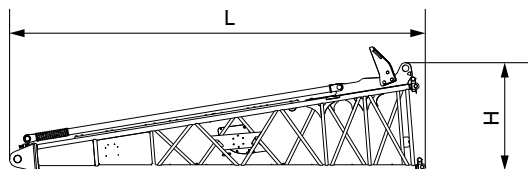
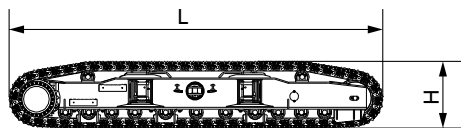
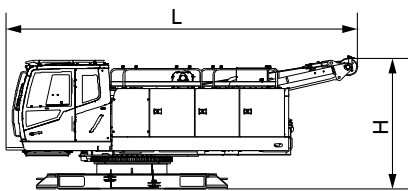
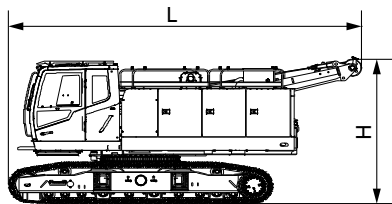
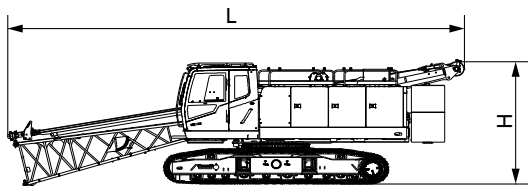
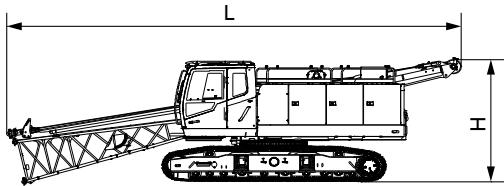

Basic Machine 1 ×1

Length (L)	11.00m
Width (W)	3.00m
Height (H)	3.24m
Weight	23.5t

Basic Machine 2 ×1

Length (L)	11.00m
Width (W)	3.00m
Height (H)	3.24m
Weight	34.0t

Basic Machine 3 ×1

Length (L)	7.28m
Width (W)	3.00m
Height (H)	3.24m
Weight	22.7t

Basic Machine 4 ×1

Length (L)	7.10m
Width (W)	3.00m
Height (H)	2.90m
Weight	13.4t

Track frame ×2

Length (L)	5.40m
Width (W)	0.83m
Height (H)	0.94m
Weight	4.67t

Boom base ×1

Length (L)	5.70m
Width (W)	1.15m
Height (H)	1.41m
Weight	0.73t

Transport Dimension

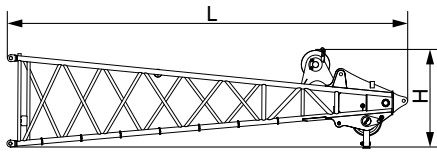

Boom top × 1

Length (L)	5.56m
Width (W)	1.15m
Height (H)	1.23m
Weight	0.46t

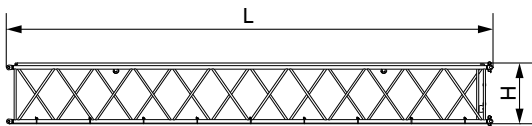

9m boom × 2

Length (L)	9.10m
Width (W)	1.15m
Height (H)	1.19m
Weight	0.44t

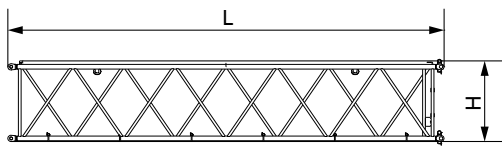

6m boom × 1

Length (L)	6.10m
Width (W)	1.15m
Height (H)	1.19m
Weight	0.31t

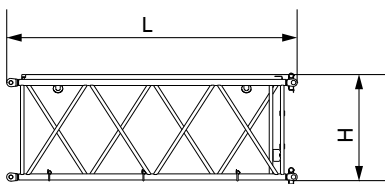

3m boom × 2

Length (L)	3.10m
Width (W)	1.15m
Height (H)	1.19m
Weight	0.18t

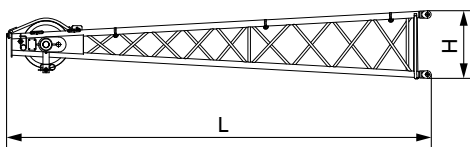

Fixed jib top × 1

Length (L)	3.38m
Width (W)	0.70m
Height (H)	0.55m
Weight	0.15t

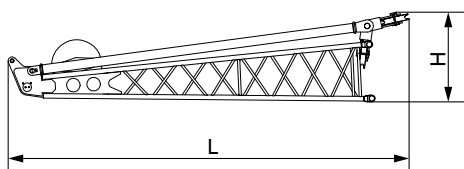

Fixed jib base and stabilization brace × 1

Length (L)	3.57m
Width (W)	0.61m
Height (H)	0.78m
Weight	0.25t

Transport Dimension

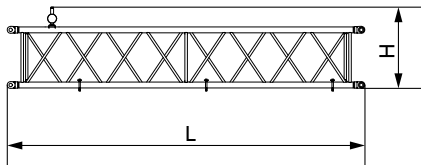

3.05m fixed jib

× 3

Length (L)	3.11m
Width (W)	0.62m
Height (H)	0.70m
Weight	0.1t

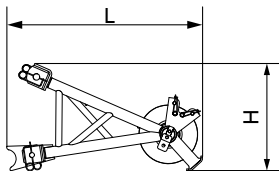

Extension jib

× 1

Length (L)	1.20m
Width (W)	0.72m
Height (H)	0.66m
Weight	0.1t

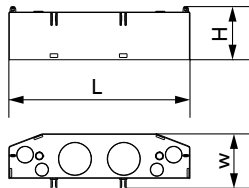

Counterweight tray

× 1

Length (L)	3.00m
Width (W)	0.97m
Height (H)	0.89m
Weight	6.0t

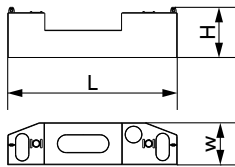

Counterweight block top

× 1

Length (L)	3.00m
Width (W)	0.80m
Height (H)	0.80m
Weight	4.5t

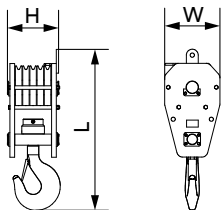

45t Hook

× 1

Length (L)	1.36m
Width (W)	0.47m
Height (H)	0.43m
Weight	0.4t

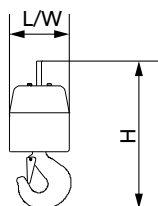

5t Ball Hook

× 1

Length (L)	0.24m
Width (W)	0.24m
Height (H)	0.66m
Weight	0.09t

Transport Plan

Trailer 1	
Part(s)	▪ Basic Machine
Weight	▪ 23.5t

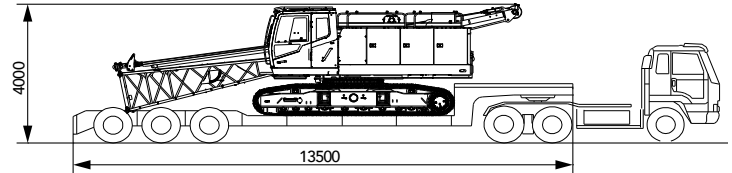

Trailer 2	
Part(s)	<ul style="list-style-type: none"> ▪ 9m boom ×2 ▪ 6m boom ×1 ▪ 3m boom ×2 ▪ Boom top ×1 ▪ Extension jib ×1 ▪ 3.05m fixed jib ×3 ▪ Fixed jib base and stabilization brace ×1 ▪ Fixed jib top ×1 ▪ 45t hook ×1 ▪ 5t hook ×1 ▪ Counterweight block ×1 ▪ Counterweight tray ×1
Weight	▪ 13.8t

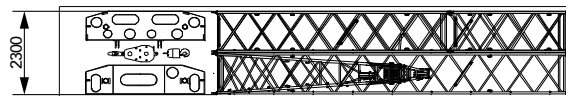
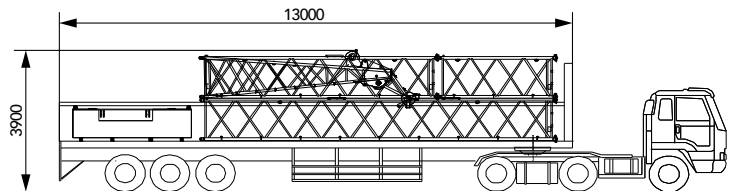



SCC450A-6
SANY CRAWLER CRANE
45 TONS LIFTING CAPACITY

QUALITY CHANGES THE WORLD

Boom Combination

- Page 18 H Configuration
- Page 21 FJ Configuration

> 16

Boom Combination

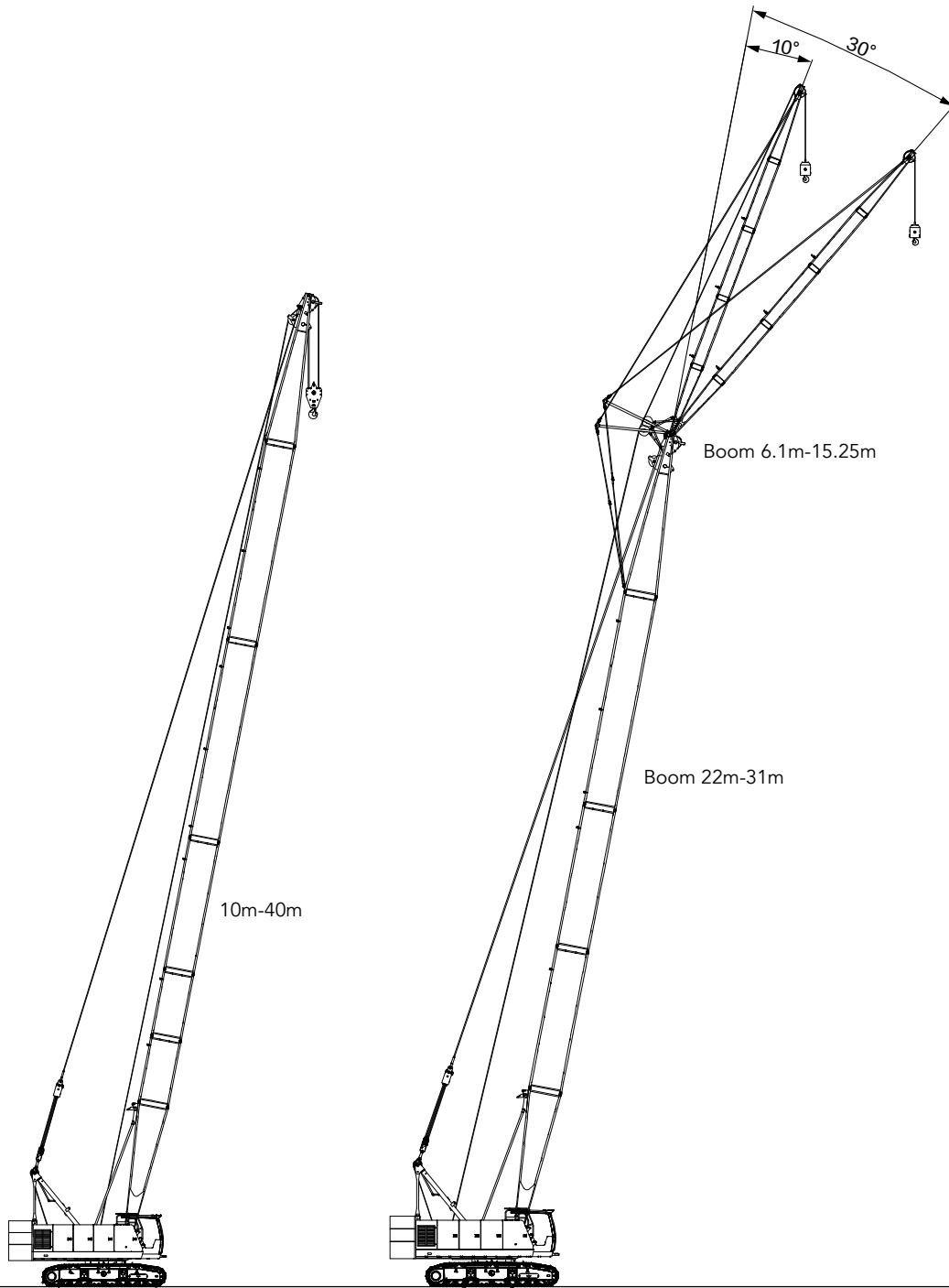

H Configuration

FJ Configuration

Note: The schematics above are just reference for loading only.

H Configuration

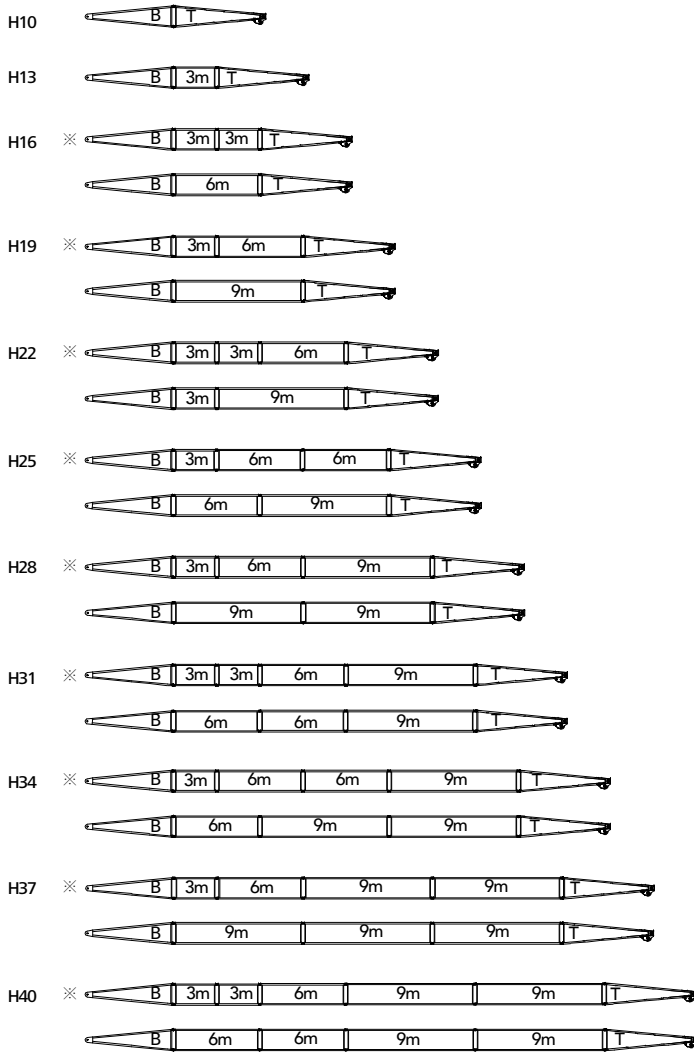

Note: * means more flexible combinations that can cover all the shorter combinations.

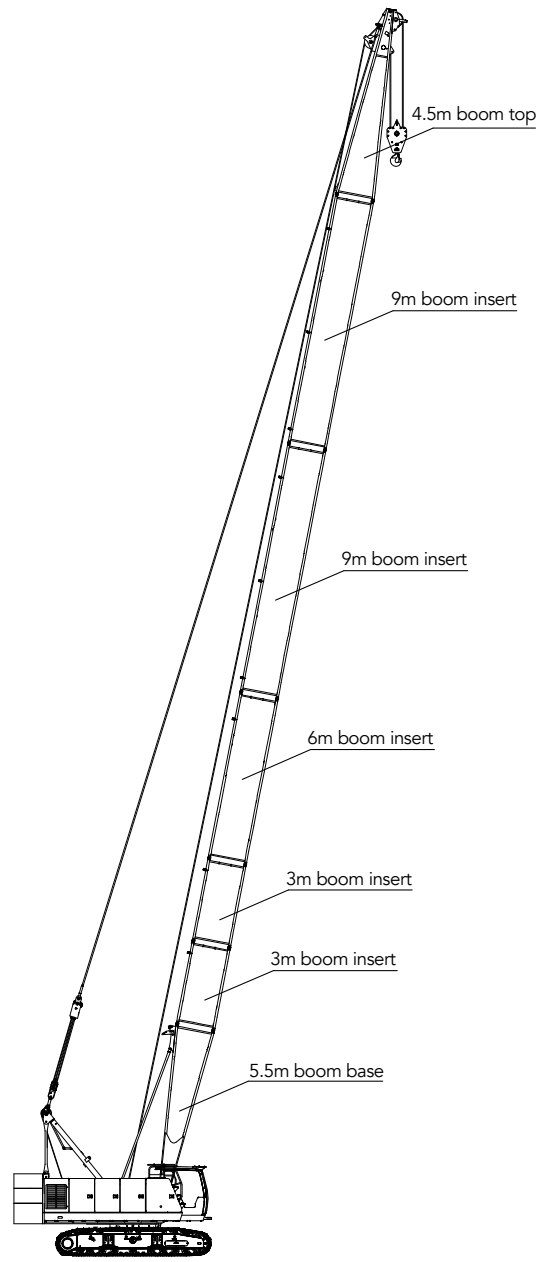
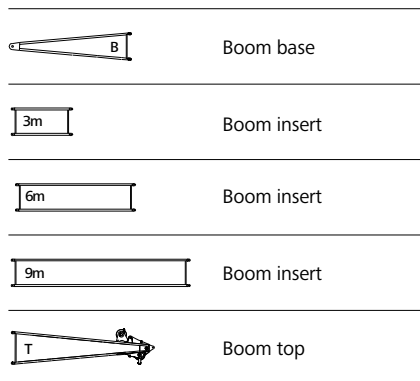

H Configuration

Working range of H Configuration

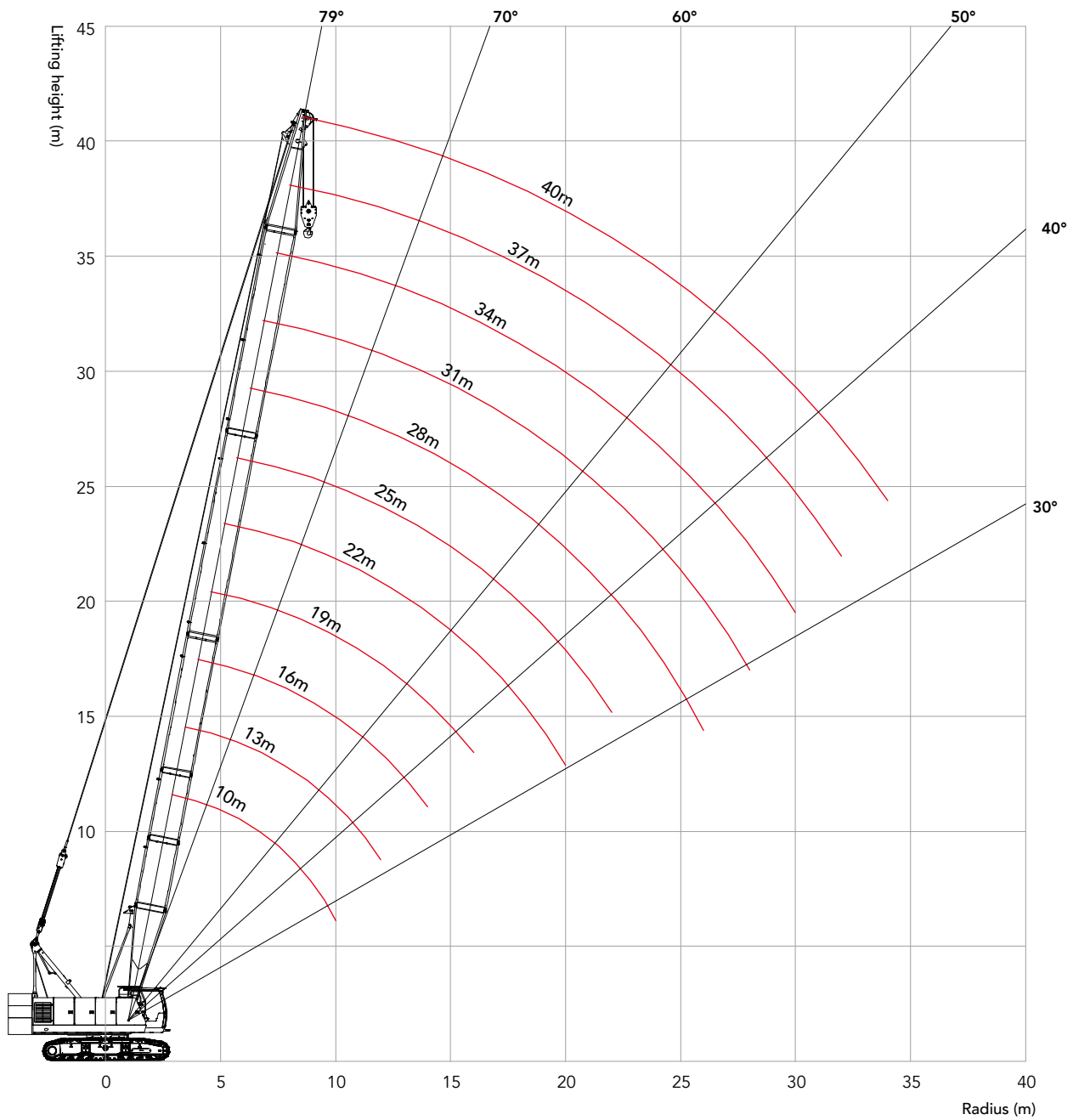

Load Chart of H Configuration

H Configuration load chart														
Rear counterweight 10.5t														
R(m)	BL(m)	10	13	16	19	22	25	28	31	34	37	40	BL(m)	R(m)
3.3	45													3.3
4	37.5	37.4	35.7											4
5	26.6	26.6	26.4	25.4	24.6									5
6	20	20	20	20	19.6	19.1	18.6							6
7	16	16	16	15.9	15.9	15.9	15.5	15.1	14.7					7
8	13.3	13.3	13.3	13.2	13.2	13.1	13.1	12.9	12.6	12.3	12			8
9	11.4	11.3	11.3	11.3	11.2	11.2	11.2	11.1	11	10.8	10.5			9
10		9.9	9.8	9.8	9.7	9.7	9.7	9.6	9.6	9.5	9.3			10
11		8.7	8.7	8.6	8.6	8.5	8.5	8.4	8.4	8.4	8.3			11
12		7.8	7.8	7.7	7.6	7.6	7.6	7.5	7.5	7.4	7.4			12
14			6.4	6.3	6.2	6.2	6.2	6.1	6	6	5.9			14
16				5.3	5.2	5.2	5.2	5.1	5	5	4.9			16
18					4.5	4.4	4.4	4.3	4.3	4.2	4.1			18
20						3.8	3.8	3.7	3.7	3.6	3.6			20
22						3.4	3.3	3.2	3.2	3.1	3.1			22
24							2.9	2.9	2.8	2.8	2.7			24
26								2.5	2.5	2.4	2.4			26
28									2.2	2.1	2.1			28
30										2	1.9	1.8		30
32											1.7	1.6		32
34												1.4		34

Notes: Rated capacity of crawler crane

- ① The rated load shown in the table is the value when the object is being lifted slowly and smoothly on a horizontal hard surface, not the value of pick & carry.
- ② The rated capacity in the load charts is calculated when the crane is parking on firm and level ground, lifting the load slowly and steadily.
- ③ The rated capacity values in the load charts are only valid when wind speed is lower than 9.8m/s.
- ④ The rated capacity in the load charts includes the weight of hook, wire rope and other riggings; therefore, the actual rated capacity shall deduct the weight of these components.
- ⑤ The crawlers must be extended during lifting.
- ⑥ The values in the load charts are valid for 360° swing.
- ⑦ The gray color part shall be subject to boom strength.
- ⑧ The values in the load charts are preliminary, which are subject to further tuning.

FJ Configuration

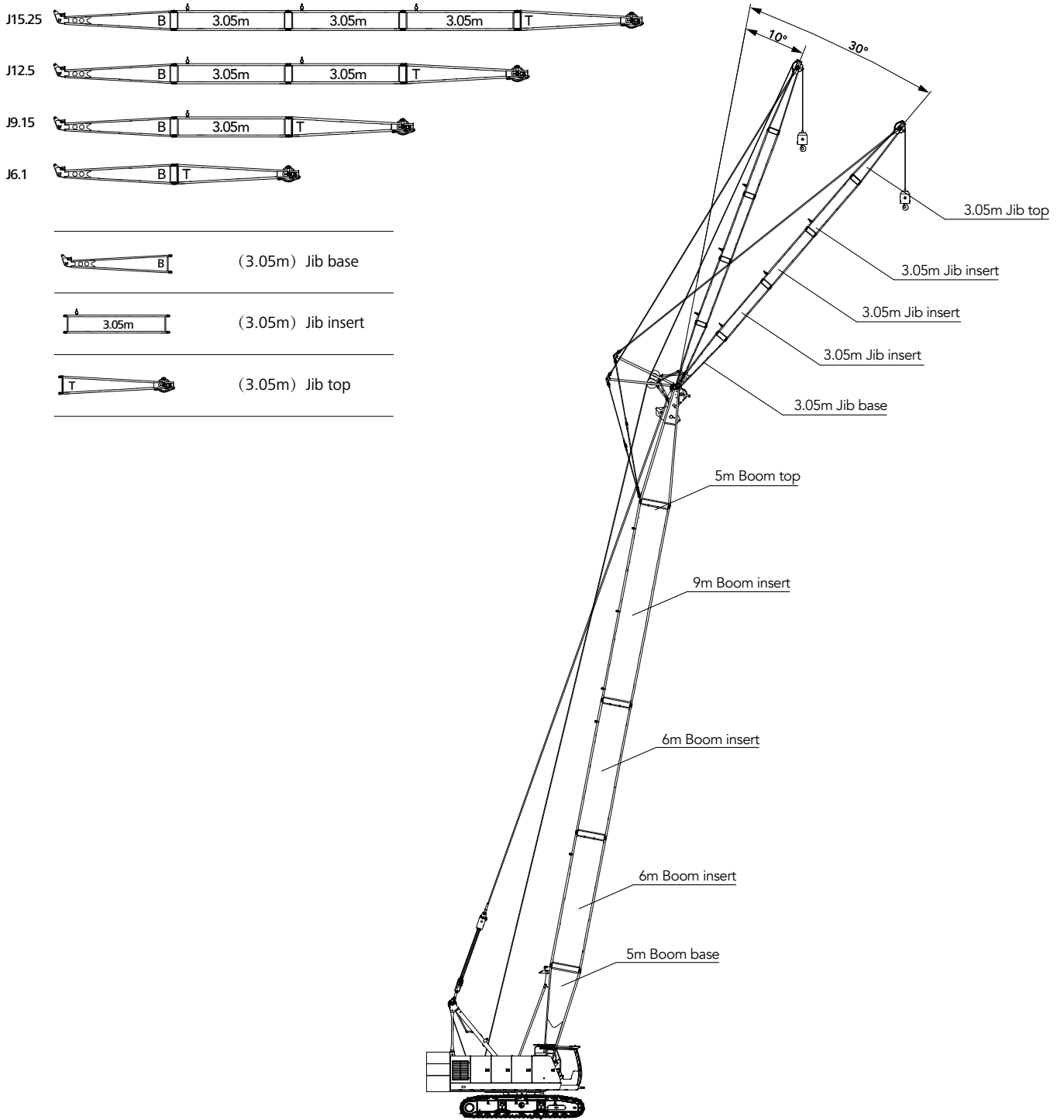

Max. boom+jib: 31m+15.25m

Working range of FJ Configuration

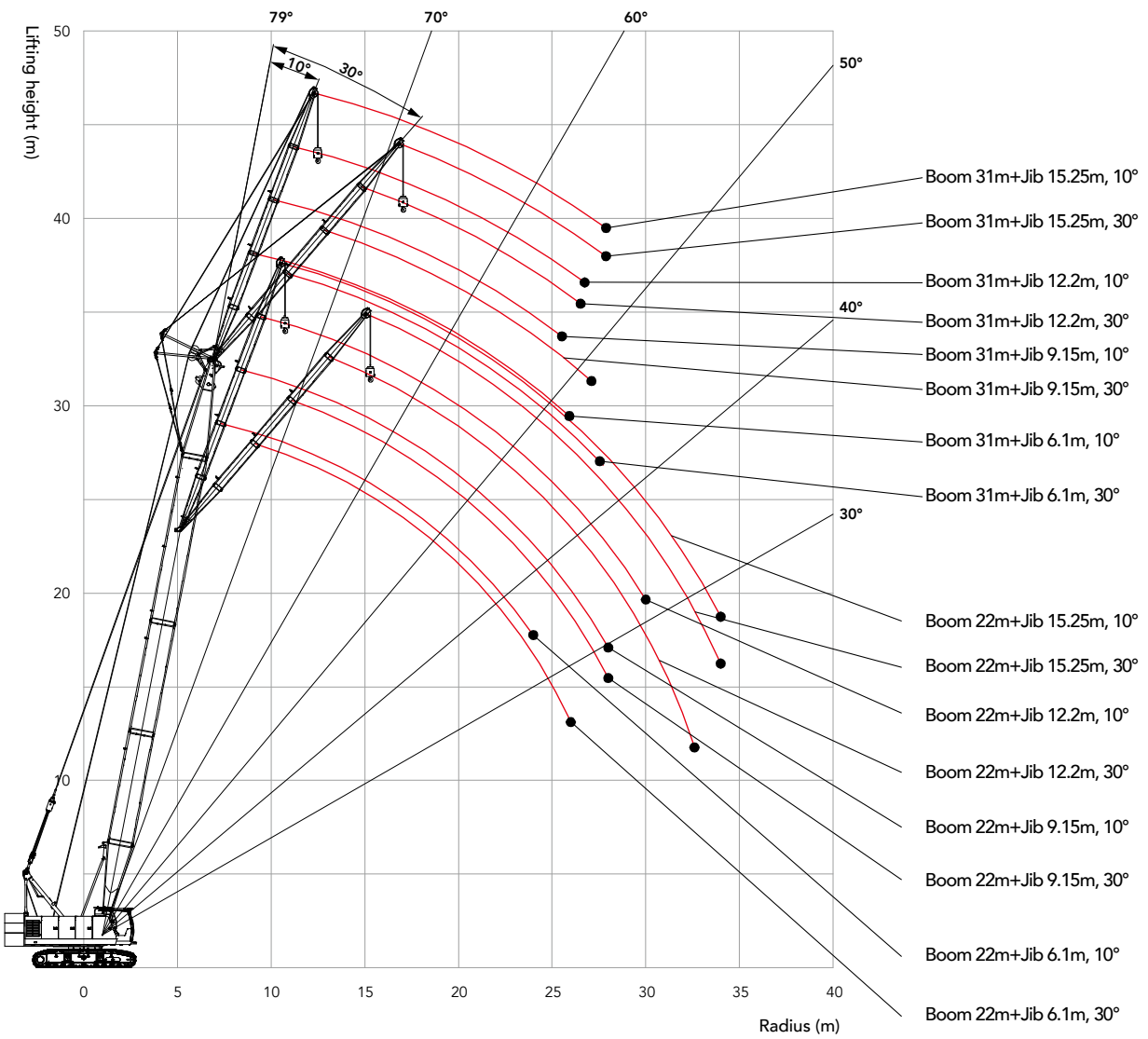

Unit: t

Load Chart of FJ Configuration

FJ Configuration load chart(Boom 22~31m, Rear counterweight 10.5t) 1/8					
Boom to jib angle 10°, Jib 6.1m					
R(m) \ BL(m)	22	25	28	31	BL(m) \ R(m)
7	5				7
8	5	5	5		8
9	5	5	5	5	9
10	5	5	5	5	10
11	5	5	5	5	11
12	5	5	5	5	12
14	5	5	5	5	14
16	5	5	5	4.9	16
18	4.3	4.3	4.2	4.1	18
20	3.7	3.7	3.6	3.5	20
22	3.2	3.2	3.1	3	22
24	2.8	2.8	2.7	2.6	24
26		2.4	2.4	2.3	26
28		2.2	2.1	2	28
30			1.9	1.8	30
32				1.6	32
Counterweight(t)	10.5	10.5	10.5	10.5	Counterweight(t)

FJ Configuration load chart(Boom 22~31m, Rear counterweight 10.5t) 2/8					
Boom to jib angle 30°, Jib 6.1m					
R(m) \ BL(m)	22	25	28	31	BL(m) \ R(m)
9	5				9
10	5	5	5		10
11	5	5	5	5	11
12	5	5	5	5	12
14	5	5	5	5	14
16	5	5	5	5	16
18	4.4	4.3	4.3	4.2	18
20	3.8	3.7	3.7	3.6	20
22	3.3	3.2	3.2	3.1	22
24	2.9	2.8	2.8	2.7	24
26	2.5	2.5	2.4	2.4	26
28		2.2	2.1	2.1	28
30			1.9	1.8	30
32				1.6	32
Counterweight(t)	10.5	10.5	10.5	10.5	Counterweight(t)

Load Chart of FJ Configuration

FJ Configuration load chart(Boom 22~31m, Rear counterweight 10.5t) 3/8

FJ Configuration load chart(Boom 22~31m, Rear counterweight 10.5t) 3/8					
Boom to jib angle 10°, Jib 9.15m					
R(m) \ BL(m)	22	25	28	31	BL(m) \ R(m)
8	5				8
9	5	5	5		9
10	5	5	5	5	10
11	5	5	5	5	11
12	5	5	5	5	12
14	5	5	5	5	14
16	5	5	5	4.9	16
18	4.4	4.3	4.2	4.2	18
20	3.8	3.7	3.6	3.6	20
22	3.3	3.2	3.2	3.1	22
24	2.9	2.8	2.8	2.7	24
26	2.5	2.5	2.4	2.3	26
28	2.2	2.2	2.1	2.1	28
30		1.9	1.9	1.8	30
32			1.7	1.6	32
34				1.4	34
36				1.2	36
Counterweight(t)	10.5	10.5	10.5	10.5	Counterweight(t)

FJ Configuration load chart(Boom 22~31m, Rear counterweight 10.5t) 4/8

FJ Configuration load chart(Boom 22~31m, Rear counterweight 10.5t) 4/8					
Boom to jib angle 30°, Jib 9.15m					
R(m) \ BL(m)	22	25	28	31	BL(m) \ R(m)
11	5				11
12	5	5	5		12
14	5	5	5	5	14
16	4.7	4.9	5	5	16
18	4.5	4.4	4.4	4.3	18
20	3.9	3.8	3.8	3.7	20
22	3.4	3.3	3.3	3.2	22
24	2.9	2.9	2.8	2.8	24
26	2.6	2.5	2.5	2.4	26
28	2.3	2.2	2.2	2.1	28
30		2	1.9	1.9	30
32			1.7	1.6	32
34			1.5	1.4	34
36				1.3	36
Counterweight(t)	10.5	10.5	10.5	10.5	Counterweight(t)

Unit: t

Load Chart of FJ Configuration

FJ Configuration load chart(Boom 22~31m, Rear counterweight 10.5t) 5/8					
Boom to jib angle 10°, Jib 12.2m					
R(m) \ BL(m)	22	25	28	31	BL(m) \ R(m)
9	5				9
10	5	5	5		10
11	5	5	5	5	11
12	5	5	5	5	12
14	5	5	5	5	14
16	5	5	5	4.8	16
18	4.4	4.3	4.3	4.2	18
20	3.8	3.7	3.7	3.6	20
22	3.3	3.2	3.2	3.1	22
24	2.9	2.8	2.8	2.7	24
26	2.6	2.5	2.4	2.4	26
28	2.3	2.2	2.2	2.1	28
30	2	2	1.9	1.8	30
32		1.8	1.7	1.6	32
34		1.6	1.5	1.4	34
36			1.3	1.3	36
38				1.1	38
Counterweight(t)	10.5	10.5	10.5	10.5	Counterweight(t)

FJ Configuration load chart(Boom 22~31m, Rear counterweight 10.5t) 6/8					
Boom to jib angle 30°, Jib 12.2m					
R(m) \ BL(m)	22	25	28	31	BL(m) \ R(m)
14	4.2	4.3	4.4		14
16	3.9	4	4.1	4.2	16
18	3.7	3.8	3.9	4	18
20	3.5	3.6	3.7	3.8	20
22	3.3	3.4	3.3	3.3	22
24	3	2.9	2.9	2.9	24
26	2.6	2.6	2.6	2.5	26
28	2.3	2.3	2.2	2.2	28
30	2.1	2	2	1.9	30
32	1.8	1.8	1.8	1.7	32
34		1.6	1.6	1.5	34
36			1.4	1.3	36
38				1.1	38
40				1	40
Counterweight(t)	10.5	10.5	10.5	10.5	Counterweight(t)

Load Chart of FJ Configuration

FJ Configuration load chart(Boom 22~31m, Rear counterweight 10.5t) 7/8					
Boom to jib angle 10°, Jib 15.25m					
R(m) \ BL(m)	22	25	28	31	BL(m) \ R(m)
10	5				10
11	5	5	5		11
12	5	5	5	5	12
14	5	5	5	5	14
16	5	5	4.9	4.7	16
18	4.4	4.4	4.3	4.1	18
20	3.8	3.7	3.7	3.6	20
22	3.3	3.3	3.2	3.1	22
24	2.9	2.8	2.8	2.7	24
26	2.6	2.5	2.5	2.4	26
28	2.3	2.2	2.2	2.1	28
30	2	2	1.9	1.8	30
32	1.8	1.8	1.7	1.6	32
34	1.6	1.6	1.5	1.4	34
36		1.4	1.3	1.3	36
38			1.2	1.1	38
40				1	40
Counterweight(t)	10.5	10.5	10.5	10.5	Counterweight(t)

Unit: t

Load Chart of FJ Configuration

FJ Configuration load chart(Boom 22~31m, Rear counterweight 10.5t) 8/8					
Boom to jib angle 30°, Jib 15.25m					
R(m) \ BL(m)	22	25	28	31	BL(m) \ R(m)
16	3.3	3.4	3.5		16
18	3.1	3.2	3.3	3.4	18
20	3	3.1	3.1	3.2	20
22	2.8	2.9	3	3.1	22
24	2.7	2.8	2.9	2.9	24
26	2.6	2.6	2.6	2.5	26
28	2.4	2.3	2.3	2.2	28
30	2.1	2.1	2	2	30
32	1.9	1.8	1.8	1.7	32
34	1.7	1.6	1.6	1.5	34
36		1.4	1.4	1.3	36
38			1.2	1.2	38
40			1.1	1	40
Counterweight(t)	10.5	10.5	10.5	10.5	Counterweight(t)

Notes: Rated capacity of crawler crane

- ① The rated load shown in the table is the value when the object is being lifted slowly and smoothly on a horizontal hard surface, not the value of pick & carry.
- ② The rated capacity in the load charts is calculated when the crane is parking on firm and level ground, lifting the load slowly and steadily.
- ③ The rated capacity values in the load charts are only valid when wind speed is lower than 9.8m/s.
- ④ The rated capacity in the load charts includes the weight of hook, wire rope and other riggings; therefore, the actual rated capacity shall deduct the weight of these components.
- ⑤ The crawlers must be extended during lifting.
- ⑥ The values in the load charts are valid for 360° swing.
- ⑦ The gray color part shall be subject to boom strength.
- ⑧ The values in the load charts are preliminary, which are subject to further tuning.



Zhejiang Sany Equipment Co.,LTD

SANY Crawler Crane Industrial Park, No. 2188 Daishan Road, Wuxing District, Huzhou City,
Zhejiang Province, P. R. China Zip 313028
Consulting sanycrane@sanygroup.com (Crane BU) / crd@sany.com.cn (IHQ)
After-sales Service 0086-400 6098 318

Reminder:

Any change in the technical parameters and configuration due to product modification or upgrade may occur without prior notice.
The machine in the picture may include additional equipment. This brochure is for reference only, and goods in kind shall prevail.
Copyright at SANY. No part of this brochure may be copied or used for any purpose without written approval from SANY.

© Edited in December 2022

